

ПА-002, P-188
0.497/-

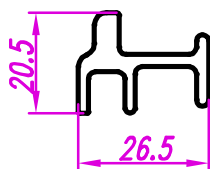

ПА-016, P-146
0.281/-

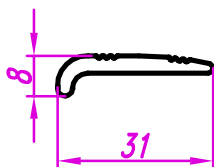

ПА-018, P-150
0.111/-

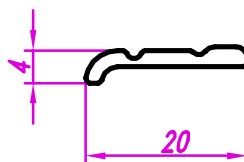

ПА-022, P-188
0.577/-

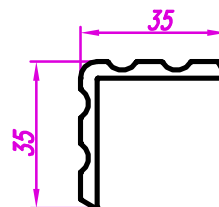

ПА-028, P-150;280
0.392/-

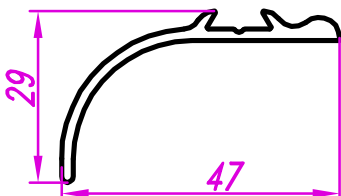

ПА-036, P-150
0.451/-

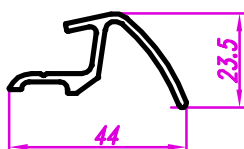

ПА-65, P-188
0.723/-

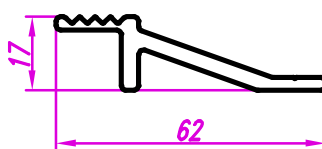

ПА-72, P-150
0.321/-

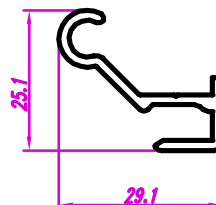

ПА-73, P-280
3.203/-

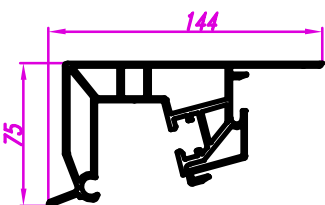

ПА-74, P-280
1.899/-

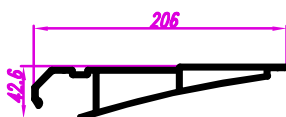

ПА-75, P-150
0.270/-

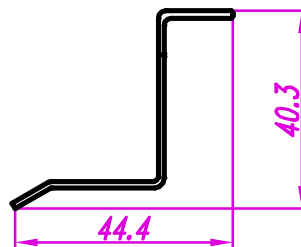

ПА-76, P-188;146
0.627/-

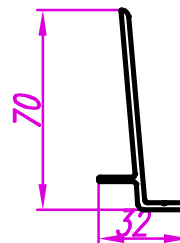

ПА-78, P-150
0.382/-

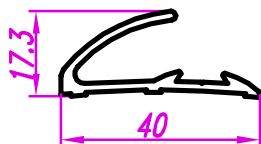

ПА-79, P-150
0.967/-

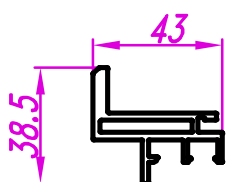

ПА-81, P-150
1.278/-

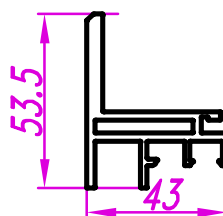

ПА-090, P-280
0.310/-

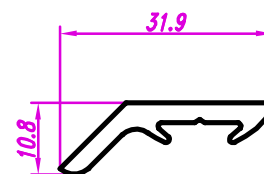

ПА-109, P-150
0.517/-

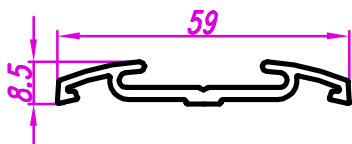

ПА-223, P-150
0.582/-



ПА-5213, P-150
1.032/-

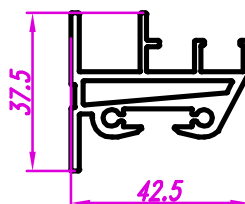

ПА-5221, P-150
1.257/-

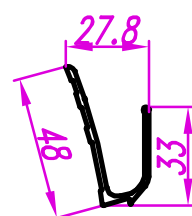

ПА-5231, P-280
1.257/-

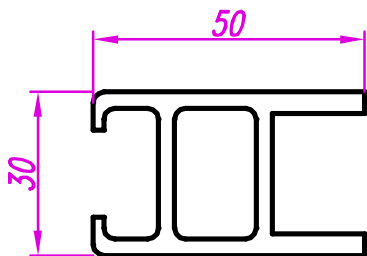

ПА-5233, P-150
0.300/-

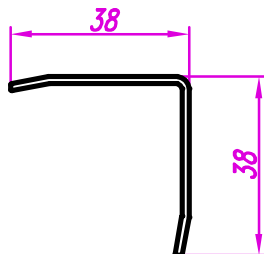

ПА-5236, P-280
5.72/-

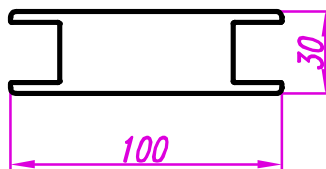

ПА-5245Д, P-188
2.700/-

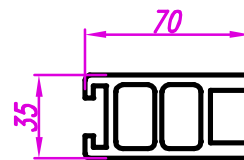

ПА-5246, P-188
0.750/-

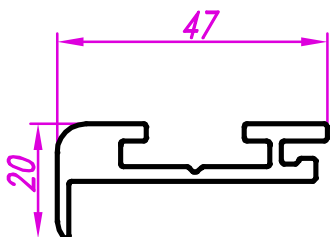

ПА-5248, P-150
1.091/-

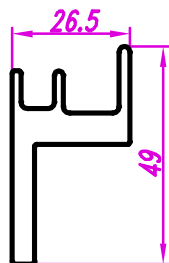

Э-10.1-01, P-188
1.455/-

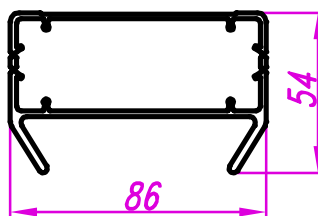

ПАС-768, P-150
0.566/-

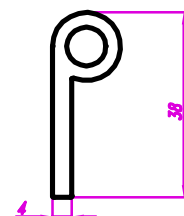

СПА-0668, P-150
1.674/-

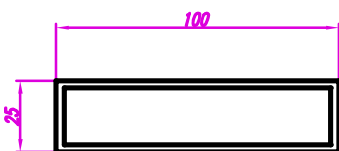

СПА-0601, P-150
1.218/-

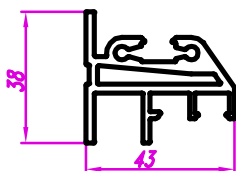

СПА-0604, P-188
0.744/-

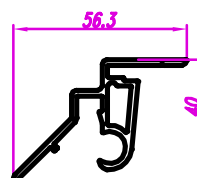

СПА-0636, P-188
1.070/-

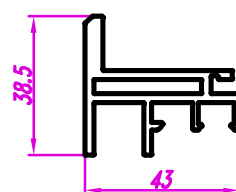

СПА-0640, P-280
1.412/-

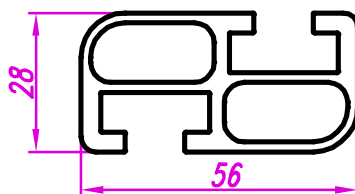

СПА-0753, P-188
0.842/-

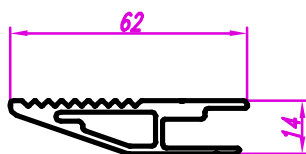

СПА-3338, P-188
0.724/-

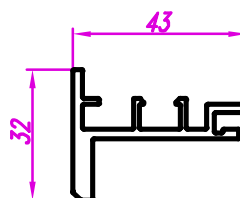

СПА-3339, P-150
0.312/-

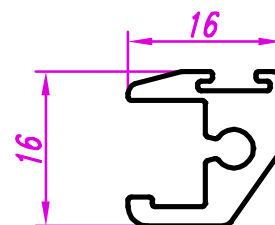

СПА-3344, P-146
0.207/-

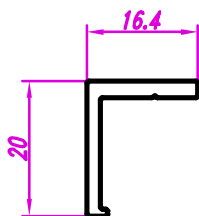

СПА-3345, P-150
0.438/-

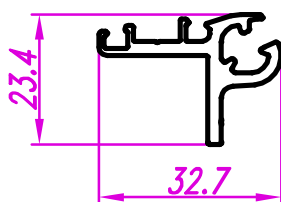

СПА-3359, P-150
0.282/-

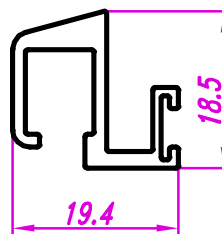

СПА-3388, P-150
0.923/-

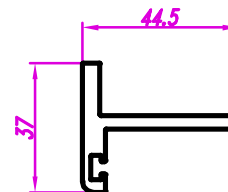

СТА-3389, P-150;146
0.867/-

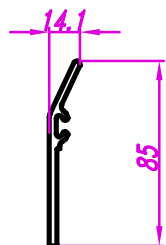

СТА-3404, P-150
0.346/-

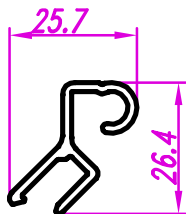

СТА-3410, P-150
1.254/-

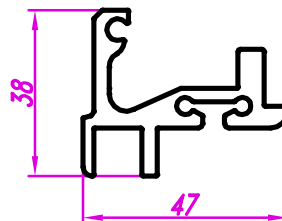

СТА-3411, P-146
0.526/-

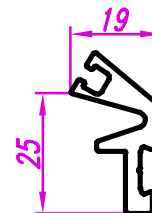

СТА-3412, P-146
0.652/-

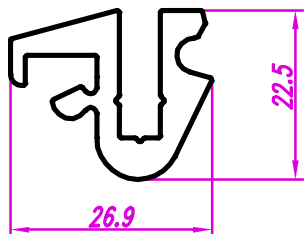

СТА-3435, P-188
0.968/-

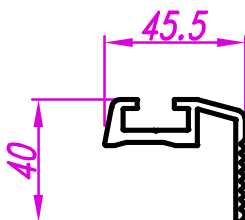

СТА-3476, P-188
0.346/-

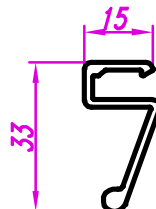

СТА-3502, P-150
0.420/-

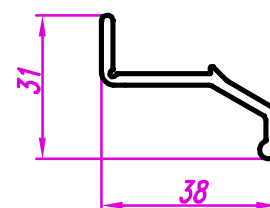

СТА-3503, P-146
0.290/-

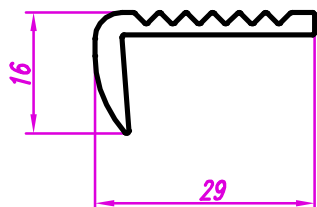

СТА-3504, P-188
1.680/-

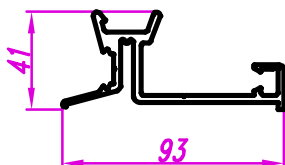

СТА-3517, P-146
0.322/-

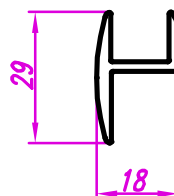

СТА-3518, P-146
0.289/-

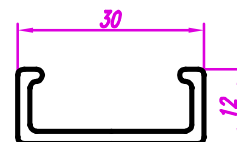

СТА-3520, P-150
0.293/-

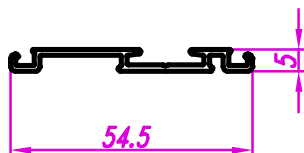

СТА-3521, P-146
0.134/-

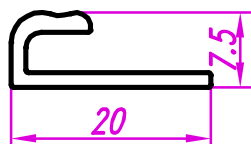

СТА-3522, P-146
0.118/-

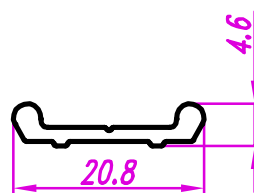

СТА-3530, P-150
0.603/-

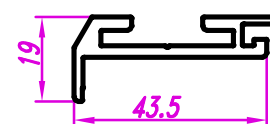

СТА-3540, P-150
0.338/-

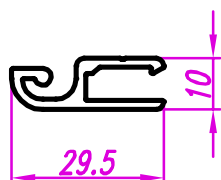

СТА-3593, P-146
0.139/-

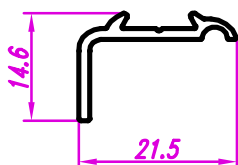

ИЧП-662, P-280
2.57/-

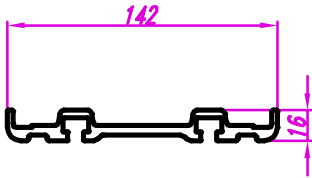

ИЧП-702-3, P-280
0.678/-

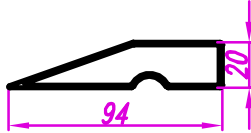

ИЧП-703, P-188
1.974/-

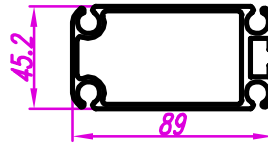

ИЧП-723, P-150
0.223/-

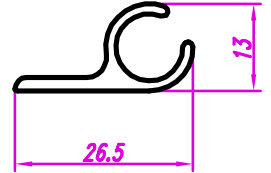

ИЧП-767, P-280
1.943/-

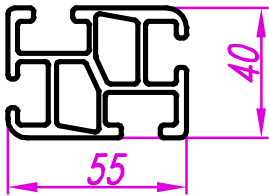

ИЧП-974, P-280
3.120/-

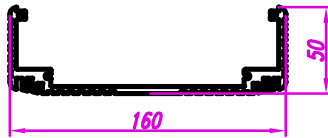

ИЧП-1112, P-146
0.103/-

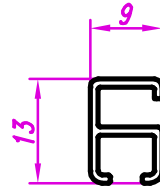

ИЧП-1374, P-280
5.674/-

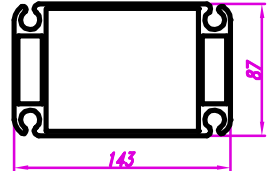

ИЧП-1696, P-280
1.290/-

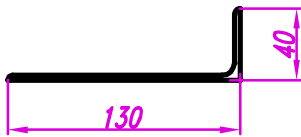

ИЧП-1826, P-146
0.360/-

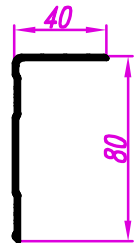

ИЧП-1871, P-280
1.160/-

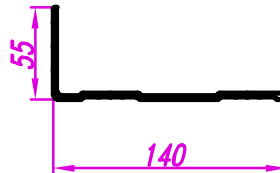

ИЧП-2047, P-188
1.160/-

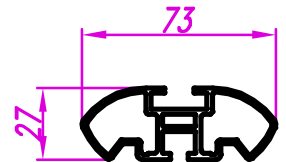

ИЧП-2150-1, P-150
0.513/-

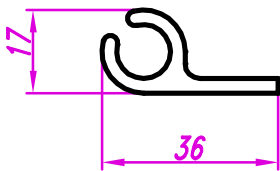

ИЧП-2296, P-150
0.507/-

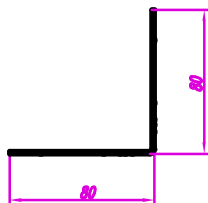

ИЧП-2297, P-146
0.378/-



ИЧП-2473-2, P-280
10.611/-

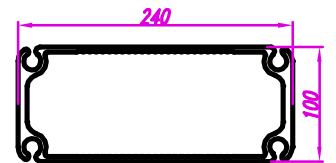

ИЧП-2619, P-280
2.510/-

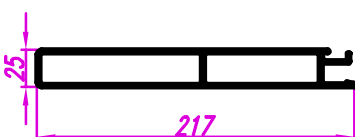

ИЧП-2622-01, P-280
2.662/-

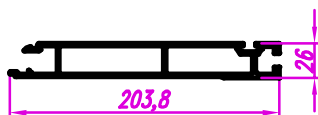

ИЧП-2625, P-150
1.460/-

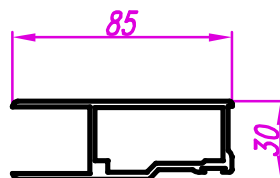

ИЧП-2732, P-280
2.836/-

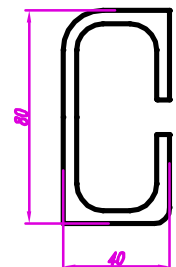

НЧТ-2736, P-150
1.050/-

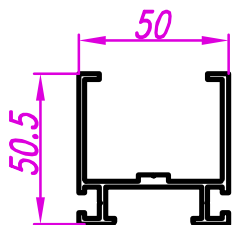

НЧТ-2857-А, P-280
3.712/-

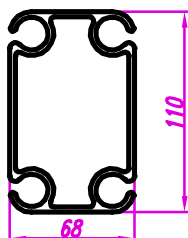

НЧТ-2954, P-280
0.990/-

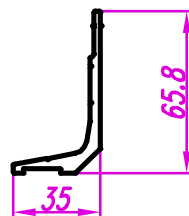

НЧТ-2962, P-188
2.003/-

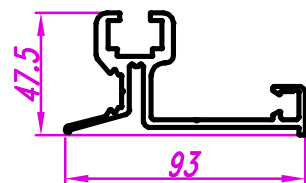

НЧТ-2995, P-280
1.652/-

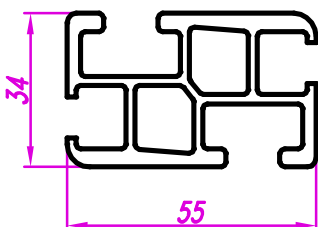

НЧТ-3249, P-188
0.345/-

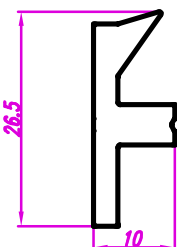

НЧТ-3251, P-280
2.150/-



НЧТ-3252, P-280
2.004/-

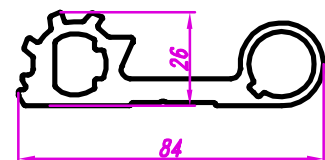

НЧТ-3253, P-280
2.167/-

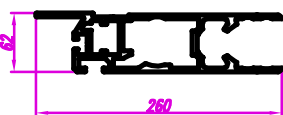

НЧТ-3305, P-280
1.365/-

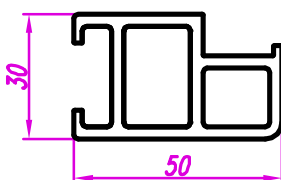

НЧТ-3306, P-280
3.255/-

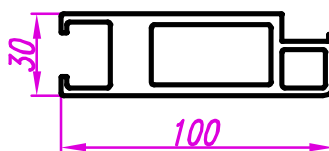

НЧТ-3337, P-150
0.438/-

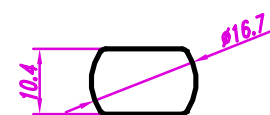

НЧТ-3390, P-188
1.340/-

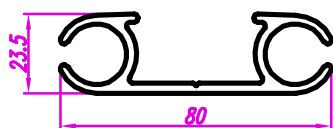

НЧТ-3403, P-146;188
0.505/-

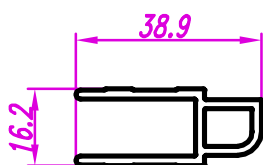

НЧТ-3404, P-146;188
0.448/-

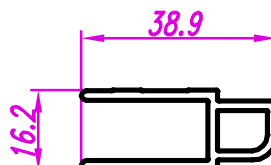

НЧТ-3405, P-150
1.291/-

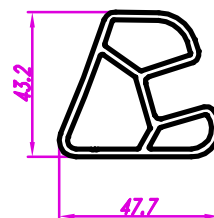

НЧТ-3413, P-150
0.543/-

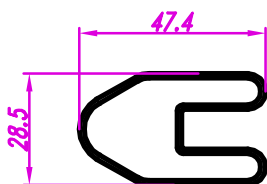

НЧТ-3534, P-150
0.335/-

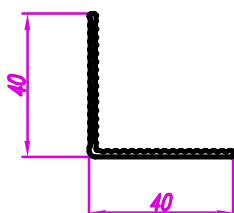

НЧТ-3623, P-146
0.517/-

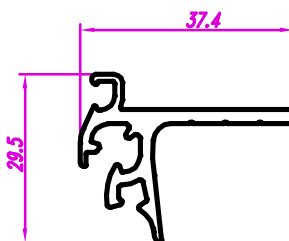

НЧТ-3663, P-280
0.541/-

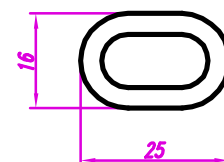

ИЧП-3664, P-150
0.140/-

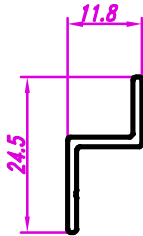

ИЧП-3793, P-146
0.216/-

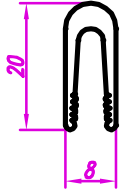

ИЧП-3799, P-150
1.125/-

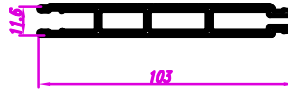

ИЧП-3800, P-280
1.679/-

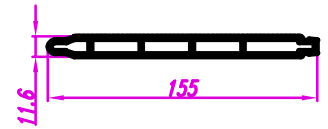

ИЧП-3801, P-280
1.635/-

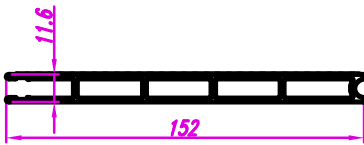

ИЧП-3814, P-150
0.695/-

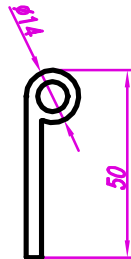

ИЧП-3856, P-150
0.634/-

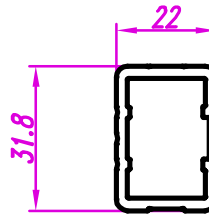

ИЧП-3920, P-280
6.301/-

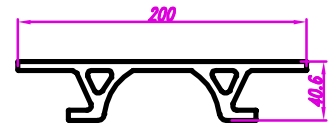

ИЧП-3924, P-150
0.658/-

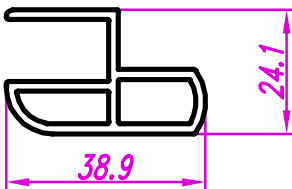

ИЧП-3976, P-150
1.213/-

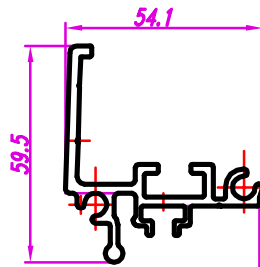

ИЧП-3977, P-280
2.897/-

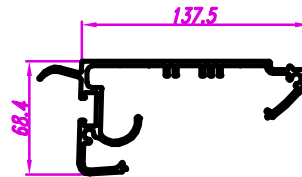

ИЧП-4045, P-280
2.893/-



ИЧП-4046, P-280
2.391/-



ИЧП-4047, P-280
2.442/-

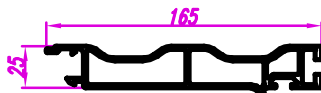

ИЧП-4048, P-188
0.983/-

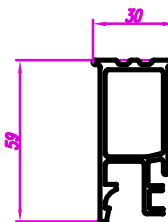

ИЧП-4049, P-188
1.09/-

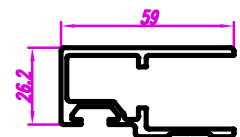

ИЧП-4050, P-280
2.937/-



ИЧП-4168, P-280
4.391/-

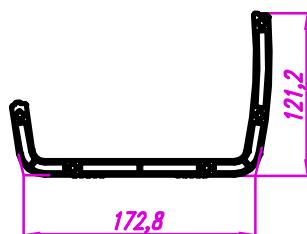

ИЧП-4217, P-146
0.284/-

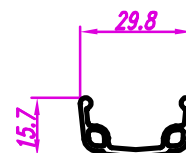

ИЧП-4383, P-188
1.694/-

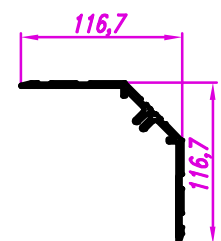

НЧП-4401, P-150
1.336/-

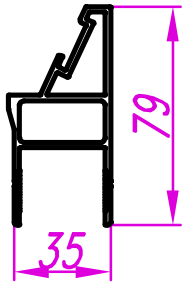

НЧП-4402, P-188
1.909/-

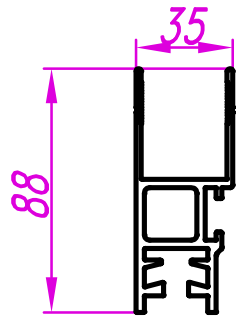

НЧП-4546, P-188
1.487/-

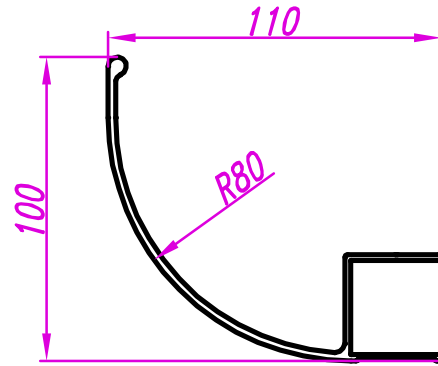

НЧП-4547, P-188
1.187/-

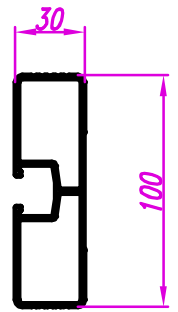

НЧП-4693, P-280
6.633/-

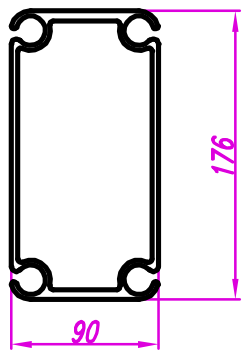

НЧП-4779, P-280
3.807/-

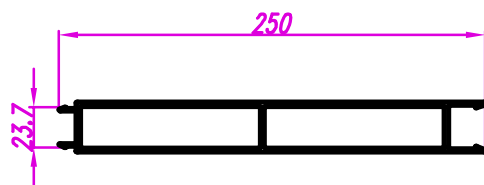

НЧП-4781, P-280
6.247/-

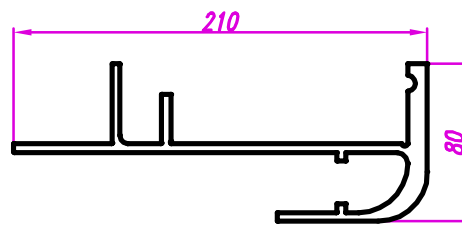

НЧП-4782, P-280
8.238/-

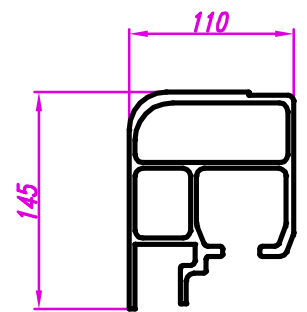

НЧП-4819, P-146
0.244/-

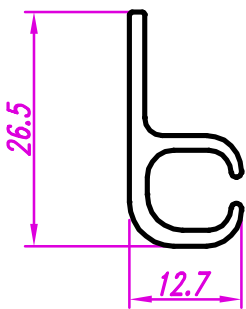

НЧП-4844, P-200
5.595/-

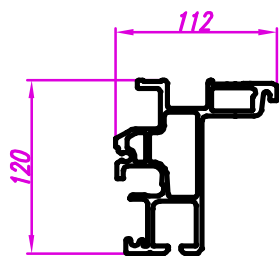

НЧП-4853, P-280
13.697/-

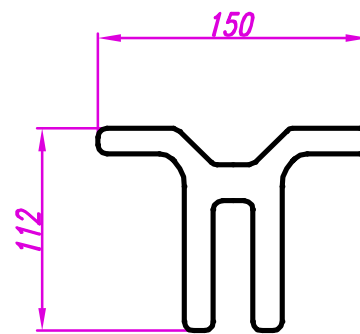

НЧП-4854, P-280
17.032/-

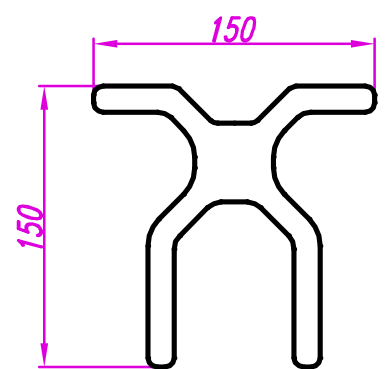

НЧП-4855, P-280
7.082/-

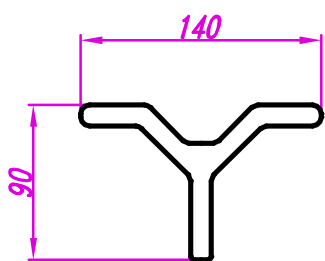

НЧП-4856, P-188
8.551/-

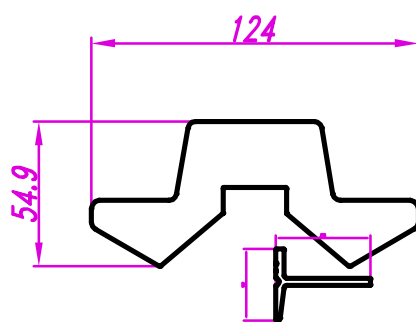

НЧП-4857, P-280
6.980/-

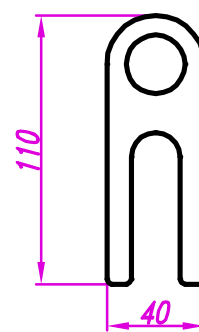

НЧП-4858, P-280
1.714/-

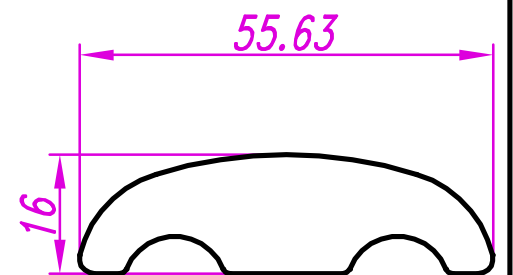

НЧП-4860, P-150
1.160/-

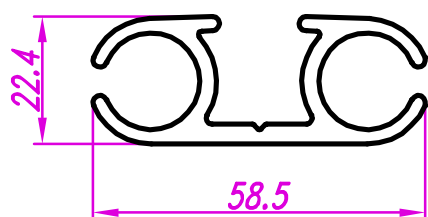

НЧП-4908, P-280
2.234/-

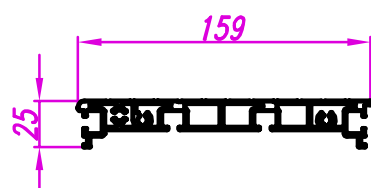

НЧП-4909, P-280
2.322/-

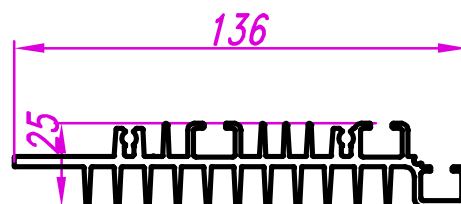

НЧП-4910, P-150
0.452/-

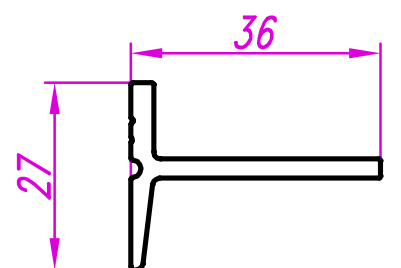

НЧТ-4946, P-188
0.792/-

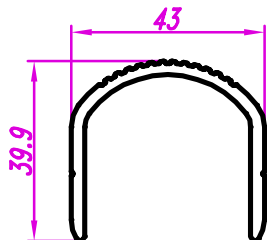

НЧТ-5062, P-188
0.583/-

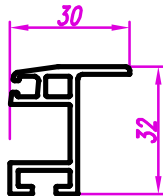

НЧТ-5090, P-280
2.538/-

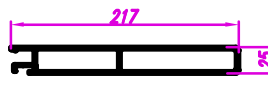

НЧТ-5091, P-280
2.536/-

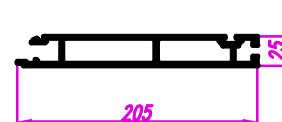

НЧТ-5092, P-280
2.260/-

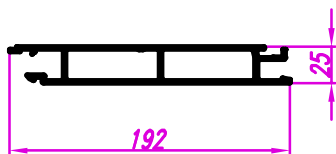

НЧТ-5093, P-280
1.976/-



НЧТ-5094, P-280
2.626/-

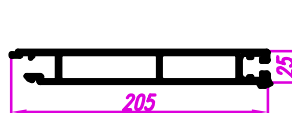

НЧТ-5095, P-280
0.608/-

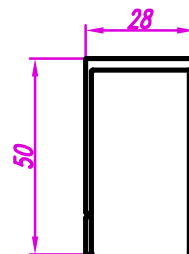

НЧТ-5122, P-200
1.424/-

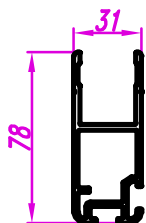

НЧТ-5324, P-280
1.078/-

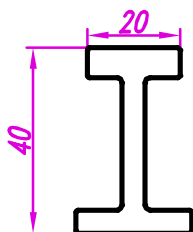

НЧТ-5375, P-200
1.840/-

